

General Description

SFGMOS[®] MOSFET is based on Oriental Semiconductor's unique device design to achieve low $R_{DS(ON)}$, low gate charge, fast switching and excellent avalanche characteristics. The low V_{th} series is specially designed to use in synchronous rectification power systems with low driving voltage.

Features

- Low $R_{DS(ON)}$ & FOM
- Extremely low switching loss
- Excellent reliability and uniformity
- Fast switching and soft recovery



Applications

- PD charger
- Motor driver
- Switching voltage regulator
- DC-DC convertor
- Switched mode power supply

Key Performance Parameters

Parameter	Value	Unit
$V_{DS, min} @ T_{j(max)}$	100	V
$I_{D, pulse}$	210	A
$R_{DS(ON) max} @ V_{GS}=10V$	10	m Ω
Q_g	49.9	nC

Marking Information

Product Name	Package	Marking
SFG10R10GF	PDFN5*6	SFG10R10G

Package & Pin information

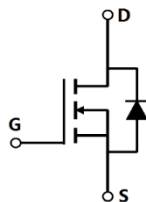

Absolute Maximum Ratings at $T_j=25^{\circ}\text{C}$ unless otherwise noted

Parameter	Symbol	Value	Unit
Drain source voltage	V_{DS}	100	V
Gate source voltage	V_{GS}	± 20	V
Continuous drain current ¹⁾ , $T_C=25^{\circ}\text{C}$	I_D	70	A
Pulsed drain current ²⁾ , $T_C=25^{\circ}\text{C}$	$I_{D, pulse}$	210	A
Continuous diode forward current ¹⁾ , $T_C=25^{\circ}\text{C}$	I_S	70	A
Diode pulsed current ²⁾ , $T_C=25^{\circ}\text{C}$	$I_{S, Pulse}$	210	A
Power dissipation ³⁾ , $T_C=25^{\circ}\text{C}$	P_D	125	W
Single pulsed avalanche energy ⁵⁾	E_{AS}	100	mJ
Operation and storage temperature	T_{stg}, T_j	-55 to 150	$^{\circ}\text{C}$

Thermal Characteristics

Parameter	Symbol	Value	Unit
Thermal resistance, junction-case	$R_{\theta JC}$	1	$^{\circ}\text{C/W}$
Thermal resistance, junction-ambient ⁴⁾	$R_{\theta JA}$	62	$^{\circ}\text{C/W}$

Electrical Characteristics at $T_j=25^{\circ}\text{C}$ unless otherwise specified

Parameter	Symbol	Min.	Typ.	Max.	Unit	Test condition
Drain-source breakdown voltage	BV_{DSS}	100			V	$V_{GS}=0\text{ V}, I_D=250\ \mu\text{A}$
Gate threshold voltage	$V_{GS(th)}$	1.0		2.5	V	$V_{DS}=V_{GS}, I_D=250\ \mu\text{A}$
Drain-source on-state resistance	$R_{DS(ON)}$		8.5	10.0	m Ω	$V_{GS}=10\text{ V}, I_D=10\text{ A}$
Drain-source on-state resistance	$R_{DS(ON)}$		9.5	12.0	m Ω	$V_{GS}=4.5\text{ V}, I_D=10\text{ A}$
Gate-source leakage current	I_{GSS}			100	nA	$V_{GS}=20\text{ V}$
				-100		$V_{GS}=-20\text{ V}$
Drain-source leakage current	I_{DSS}			1	μA	$V_{DS}=100\text{ V}, V_{GS}=0\text{ V}$
Gate resistance	R_G		4.5		Ω	$f=1\text{ MHz}, \text{Open drain}$

Dynamic Characteristics

Parameter	Symbol	Min.	Typ.	Max.	Unit	Test condition
Input capacitance	C_{iss}		2604		pF	$V_{GS}=0\text{ V}$, $V_{DS}=50\text{ V}$, $f=1\text{ MHz}$
Output capacitance	C_{oss}		361		pF	
Reverse transfer capacitance	C_{rss}		6.5		pF	
Turn-on delay time	$t_{d(on)}$		20.6		ns	$V_{GS}=10\text{ V}$, $V_{DS}=50\text{ V}$, $R_G=2.2\ \Omega$, $I_D=25\text{ A}$
Rise time	t_r		5		ns	
Turn-off delay time	$t_{d(off)}$		51.8		ns	
Fall time	t_f		9		ns	

Gate Charge Characteristics

Parameter	Symbol	Min.	Typ.	Max.	Unit	Test condition
Total gate charge	Q_g		49.9		nC	$V_{GS}=10\text{ V}$, $V_{DS}=50\text{ V}$, $I_D=25\text{ A}$
Gate-source charge	Q_{gs}		6.5		nC	
Gate-drain charge	Q_{gd}		12.4		nC	
Gate plateau voltage	$V_{plateau}$		3.4		V	

Body Diode Characteristics

Parameter	Symbol	Min.	Typ.	Max.	Unit	Test condition
Diode forward voltage	V_{SD}			1.3	V	$I_S=12\text{ A}$, $V_{GS}=0\text{ V}$
Reverse recovery time	t_{rr}		60.4		ns	$V_R=50\text{ V}$, $I_S=12\text{ A}$, $di/dt=100\text{ A}/\mu\text{s}$
Reverse recovery charge	Q_{rr}		106.1		nC	
Peak reverse recovery current	I_{rrm}		3		A	

Note

- 1) Calculated continuous current based on maximum allowable junction temperature.
- 2) Repetitive rating; pulse width limited by max. junction temperature.
- 3) P_d is based on max. junction temperature, using junction-case thermal resistance.
- 4) The value of $R_{\theta JA}$ is measured with the device mounted on 1 in 2 FR-4 board with 2oz. Copper, in a still air environment with $T_a=25\text{ }^\circ\text{C}$.
- 5) $V_{DD}=50\text{ V}$, $V_{GS}=10\text{ V}$, $L=0.3\text{ mH}$, starting $T_j=25\text{ }^\circ\text{C}$.

Electrical Characteristics Diagrams

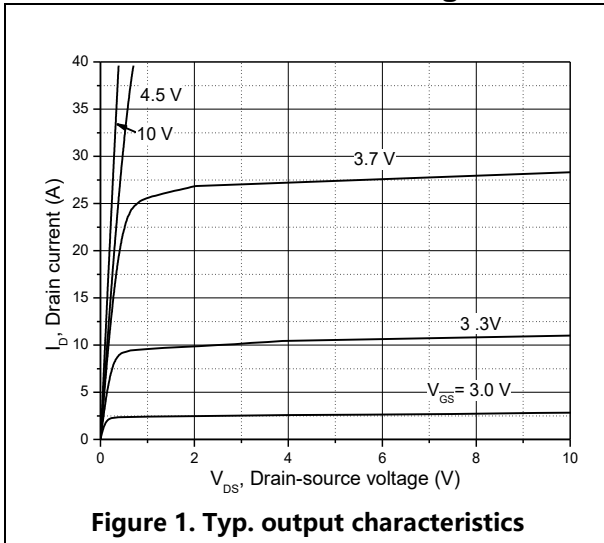

Figure 1. Typ. output characteristics

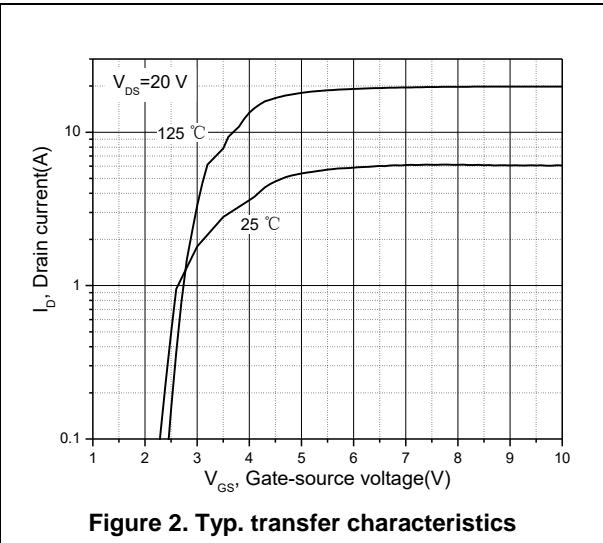

Figure 2. Typ. transfer characteristics

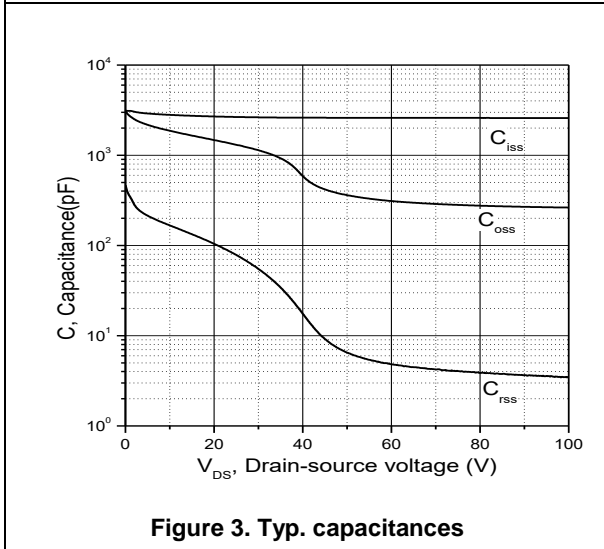

Figure 3. Typ. capacitances

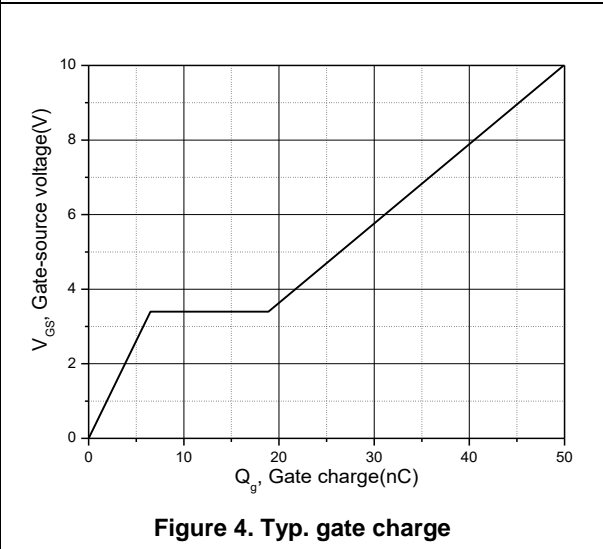

Figure 4. Typ. gate charge

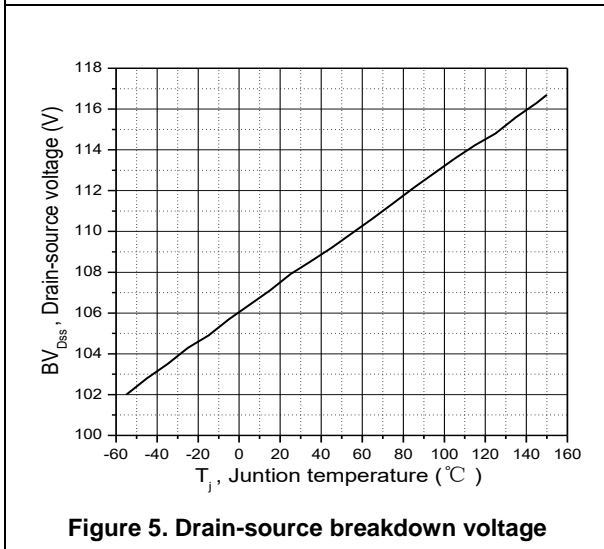

Figure 5. Drain-source breakdown voltage

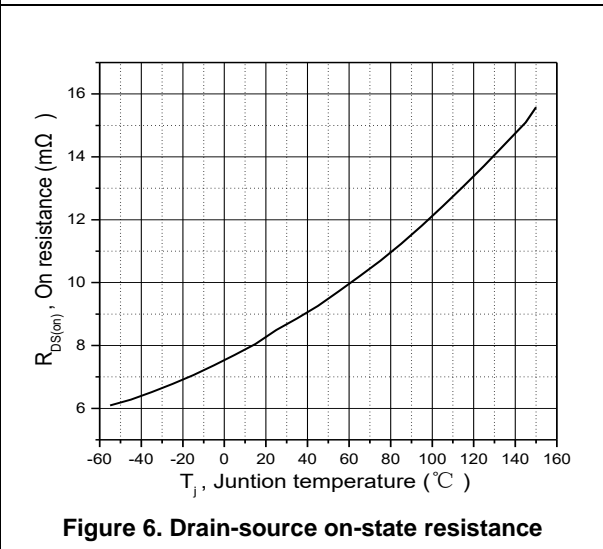
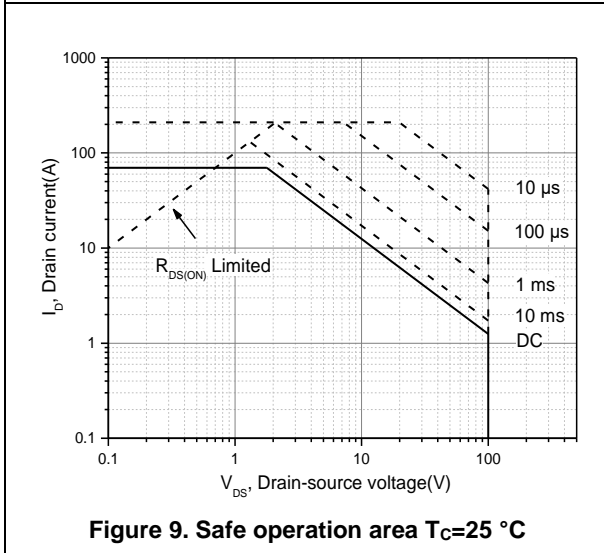
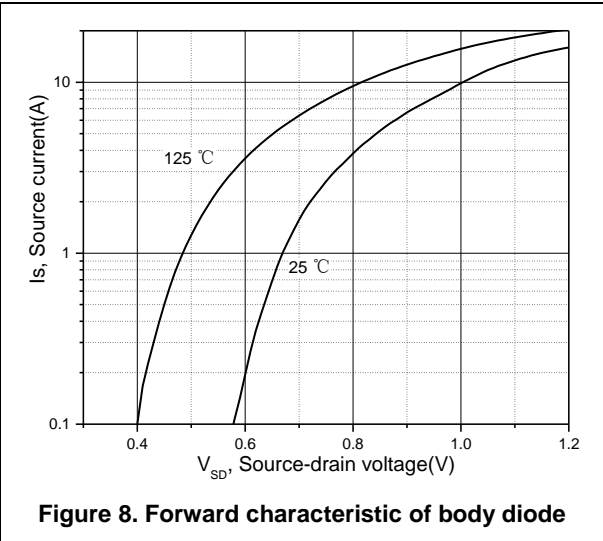
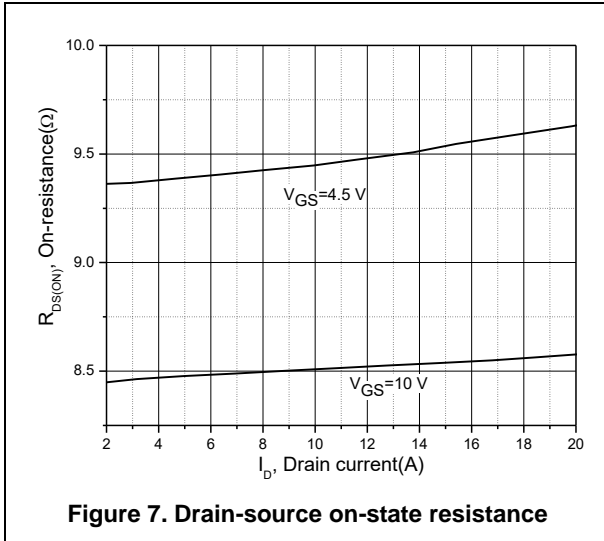

Figure 6. Drain-source on-state resistance



Test circuits and waveforms

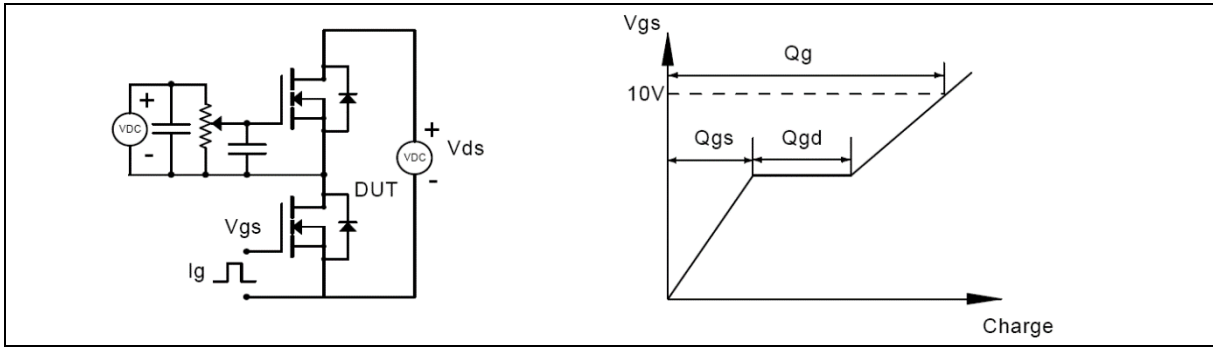

Figure 1. Gate charge test circuit & waveform

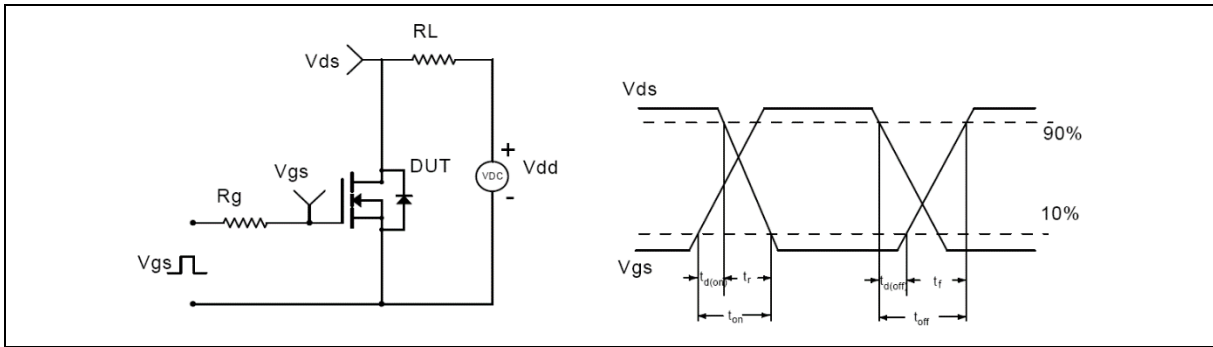

Figure 2. Switching time test circuit & waveforms

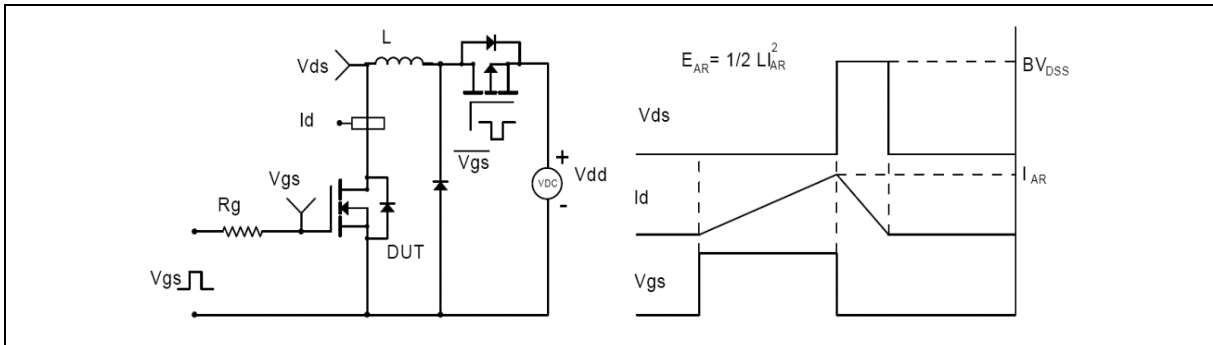

Figure 3. Unclamped inductive switching (UIS) test circuit & waveforms

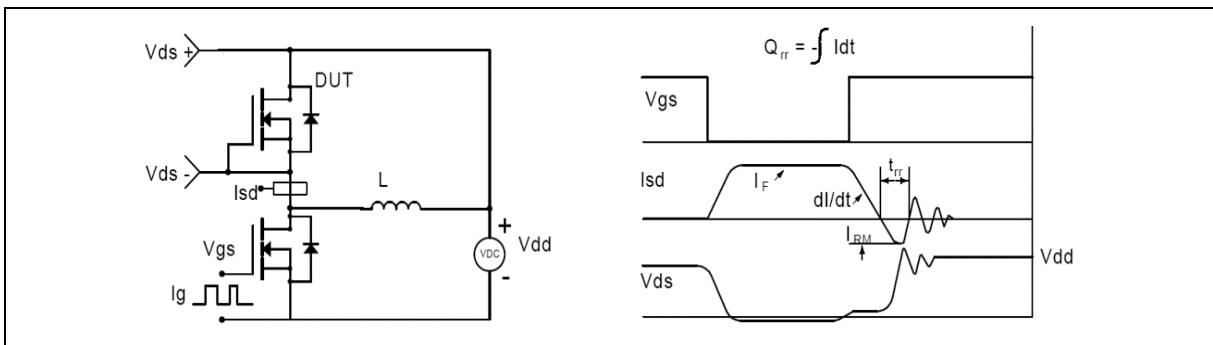
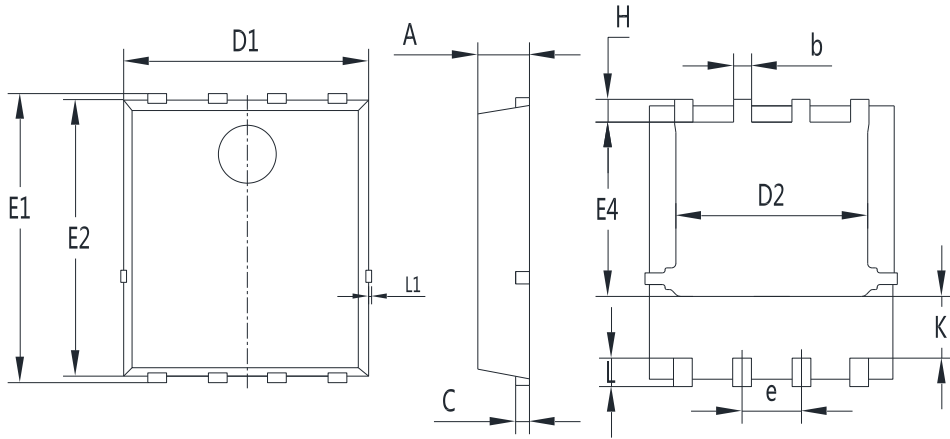

Figure 4. Diode reverse recovery test circuit & waveforms

Package Information



Symbol	mm		
	Min	Nom	Max
A	1.00	1.10	1.20
b	0.30	0.40	0.50
c	0.154	0.254	0.354
D1	5.00	5.20	5.40
D2	3.80	4.10	4.25
e	1.17	1.27	1.37
E1	5.95	6.15	6.35
E2	5.66	5.86	6.06
E4	3.52	3.72	3.92
H	0.40	0.50	0.60
L	0.30	0.60	0.70
L1	0.12 REF		
K	1.15	1.30	1.45

Version 1: PDFN5*6-C package outline dimension

Package Information

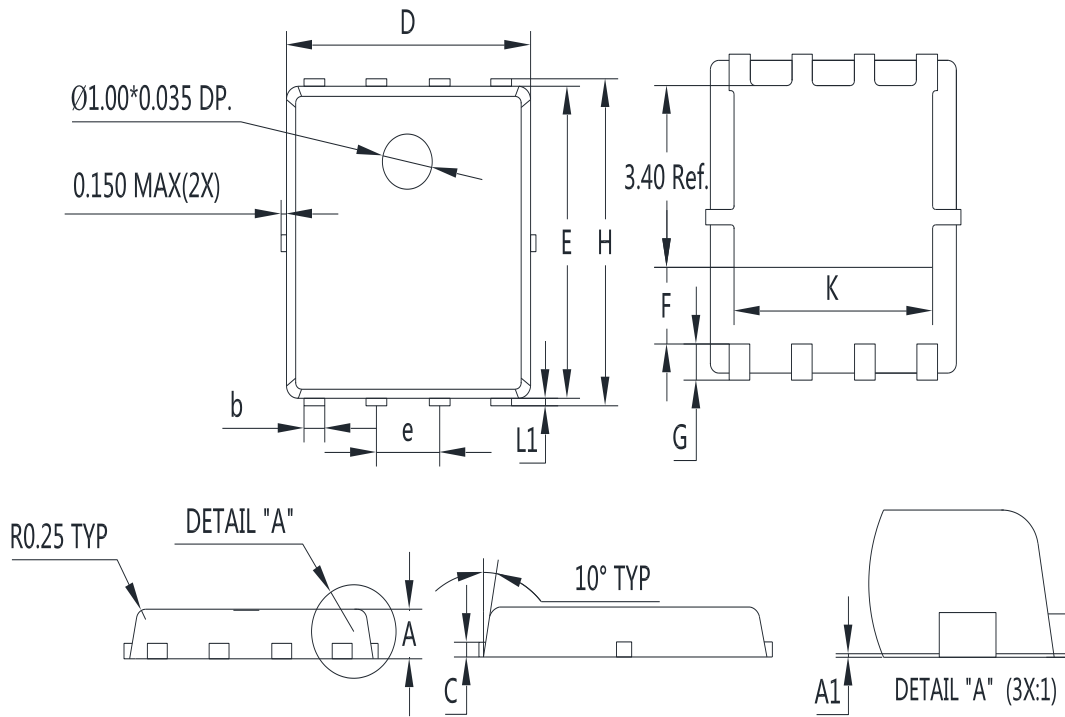

Symbol	mm		
	Min	Nom	Max
A	0.8	0.9	1.0
A1	0	0.03	0.05
b	0.35	0.42	0.49
c	0.254 REF		
D	4.9	5.0	5.1
F	1.40 REF		
E	5.7	5.8	5.9
e	1.27 BSC		
H	5.95	6.08	6.20
L1	0.10	0.14	0.18
G	0.60 REF		
K	4.00 REF		

Version 2: PDFN5*6-K package outline dimension

Ordering Information

Package Type	Units/ Reel	Reels / Inner Box	Units/ Inner Box	Inner Boxes/ Carton Box	Units/ Carton Box
PDFN5*6-C	5000	2	10000	5	50000
PDFN5*6-K	5000	2	10000	5	50000

Product Information

Product	Package	Pb Free	RoHS	Halogen Free
SFG10R10GF	PDFN5*6	yes	yes	yes

Legal Disclaimer

The information given in this document shall in no event be regarded as a guarantee of conditions or characteristics. With respect to any examples or hints given herein, any typical values stated herein and/or any information regarding the application of the device, Oriental Semiconductor hereby disclaims any and all warranties and liabilities of any kind, including without limitation, warranties of non-infringement of intellectual property rights of any third party.

For further information on technology, delivery terms and conditions and prices, please contact the Oriental Semiconductor sales representatives (www.orientalsemi.com).

© Oriental Semiconductor Co.,Ltd. All Rights Reserved /