

N-channel MOSFET

## Features

- Low gate charge
- 100% avalanche tested
- Improved dv/dt capability
- RoHS compliant
- JEDEC Qualification

$BV_{DSS}$	$I_D$	$R_{DS(on)}$
500V	23A	< 0.22Ω

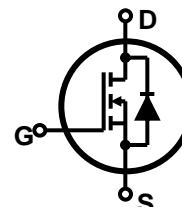
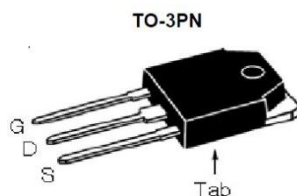

Device	Package	Marking	Remark
TMAN23N50A	TO-3PN	TMAN23N50A	RoHS

## Absolute Maximum Ratings

Parameter	Symbol	TMAN23N50A	Unit
Drain-Source Voltage	$V_{DS}$	500	V
Gate-Source Voltage	$V_{GS}$	±30	V
Continuous Drain Current	$I_D$	$T_C = 25\text{ }^\circ\text{C}$	23
		$T_C = 100\text{ }^\circ\text{C}$	14.5
Pulsed Drain Current (Note 1)	$I_{DM}$	92	A
Single Pulse Avalanche Energy (Note 2)	$E_{AS}$	822	mJ
Repetitive Avalanche Current (Note 1)	$I_{AR}$	23	A
Repetitive Avalanche Energy (Note 1)	$E_{AR}$	34.7	mJ
Power Dissipation	$P_D$	$T_C = 25\text{ }^\circ\text{C}$	347
		Derate above 25 °C	2.77
Peak Diode Recovery dv/dt (Note 3)	dv/dt	4.5	V/ns
Operating Junction and Storage Temperature Range	$T_J, T_{STG}$	-55~150	°C
Maximum lead temperature for soldering purposes, 1/8" from case for 5 seconds	$T_L$	300	°C

\* Limited only by maximum junction temperature

## Thermal Characteristics

Parameter	Symbol	TMAN23N50A	Unit
Maximum Thermal resistance, Junction-to-Case	$R_{\theta JC}$	0.36	°C/W
Maximum Thermal resistance, Junction-to-Ambient	$R_{\theta JA}$	62.5	°C/W

**Electrical Characteristics :  $T_C=25^\circ\text{C}$ , unless otherwise noted**

Parameter	Symbol	Test condition	Min	Typ	Max	Units
<b>OFF</b>						
Drain-Source Breakdown Voltage	$BV_{DSS}$	$V_{GS} = 0\text{ V}, I_D = 250\ \mu\text{A}$	500	--	--	V
Zero Gate Voltage Drain Current	$I_{DSS}$	$V_{DS} = 500\text{ V}, V_{GS} = 0\text{ V}$	--	--	1	$\mu\text{A}$
		$V_{DS} = 400\text{ V}, T_C = 125^\circ\text{C}$	--	--	10	$\mu\text{A}$
Forward Gate-Source Leakage Current	$I_{GSSF}$	$V_{GS} = 30\text{ V}, V_{DS} = 0\text{ V}$	--	--	100	nA
Reverse Gate-Source Leakage Current	$I_{GSSR}$	$V_{GS} = -30\text{ V}, V_{DS} = 0\text{ V}$	--	--	-100	nA

**ON**

Gate Threshold Voltage	$V_{GS(th)}$	$V_{DS} = V_{GS}, I_D = 250\ \mu\text{A}$	3	--	5	V
Drain-Source On-Resistance	$R_{DS(on)}$	$V_{GS} = 10\text{ V}, I_D = 11.5\text{ A}$	--	0.185	0.22	$\Omega$
Forward Transconductance <sup>(Note 4)</sup>	$g_{FS}$	$V_{DS} = 30\text{ V}, I_D = 11.5\text{ A}$	--	28	--	S

**DYNAMIC**

Input Capacitance	$C_{iss}$	$V_{DS} = 25\text{ V}, V_{GS} = 0\text{ V},$ $f = 1.0\text{ MHz}$	--	3270	--	pF
Output Capacitance	$C_{oss}$		--	360	--	pF
Reverse Transfer Capacitance	$C_{rss}$		--	16	--	pF

**SWITCHING**

Turn-On Delay Time <sup>(Note 4,5)</sup>	$t_{d(on)}$	$V_{DD} = 250\text{ V}, I_D = 23\text{ A},$ $R_G = 25\ \Omega$	--	100	--	ns
Turn-On Rise Time <sup>(Note 4,5)</sup>	$t_r$		--	100	--	ns
Turn-Off Delay Time <sup>(Note 4,5)</sup>	$t_{d(off)}$		--	240	--	ns
Turn-Off Fall Time <sup>(Note 4,5)</sup>	$t_f$		--	60	--	ns
Total Gate Charge <sup>(Note 4,5)</sup>	$Q_g$	$V_{DS} = 400\text{ V}, I_D = 23\text{ A},$ $V_{GS} = 10\text{ V}$	--	64	--	nC
Gate-Source Charge <sup>(Note 4,5)</sup>	$Q_{gs}$		--	17	--	nC
Gate-Drain Charge <sup>(Note 4,5)</sup>	$Q_{gd}$		--	25	--	nC

**SOURCE DRAIN DIODE**

Maximum Continuous Drain-Source Diode Forward Current	$I_S$	---	--	--	23	A
Maximum Pulsed Drain-Source Diode Forward Current	$I_{SM}$	---	--	--	92	A
Drain-Source Diode Forward Voltage	$V_{SD}$	$V_{GS} = 0\text{ V}, I_S = 23\text{ A}$	--	--	1.5	V
Reverse Recovery Time <sup>(Note 4)</sup>	$t_{rr}$	$V_{GS} = 0\text{ V}, I_S = 23\text{ A}$ $di_F / dt = 100\text{ A}/\mu\text{s}$	--	430	--	ns
Reverse Recovery Charge <sup>(Note 4)</sup>	$Q_{rr}$		--	5.9	--	$\mu\text{C}$

Note :

1. Repeated rating : Pulse width limited by safe operating area
2.  $L=2.8\text{mH}, I_{AS} = 23\text{A}, V_{DD} = 50\text{V}, R_G = 25\Omega,$  Starting  $T_J = 25^\circ\text{C}$
3.  $I_{SD} \leq 23\text{A}, di/dt \leq 200\text{A}/\mu\text{s}, V_{DD} \leq BV_{DS},$  Starting  $T_J = 25^\circ\text{C}$
4. Pulse Test : Pulse width  $\leq 300\mu\text{s},$  Duty Cycle  $\leq 2\%$
5. Essentially Independent of Operating Temperature Typical Characteristics

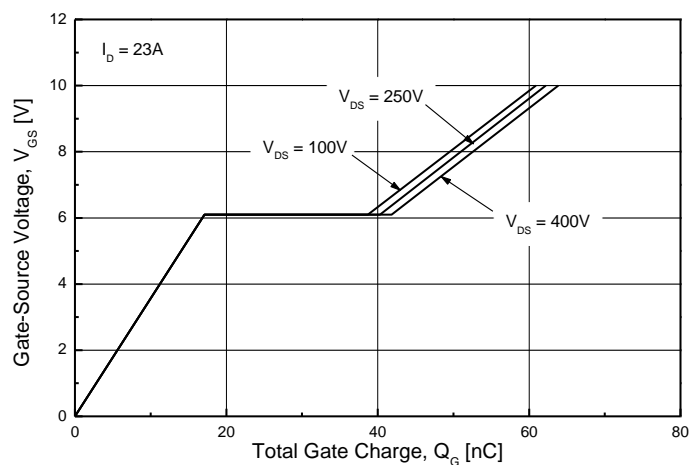
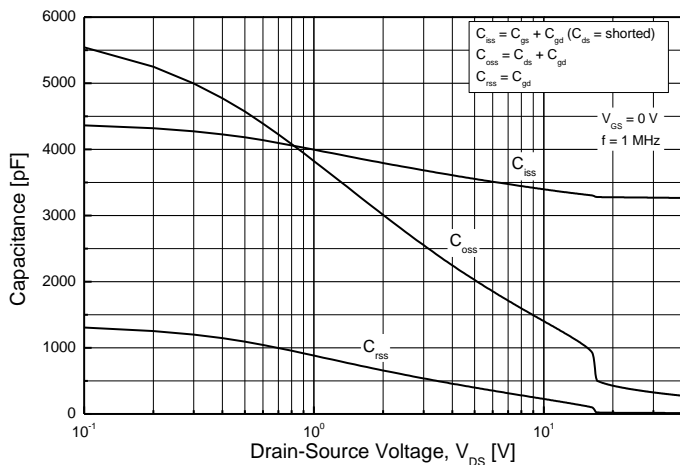
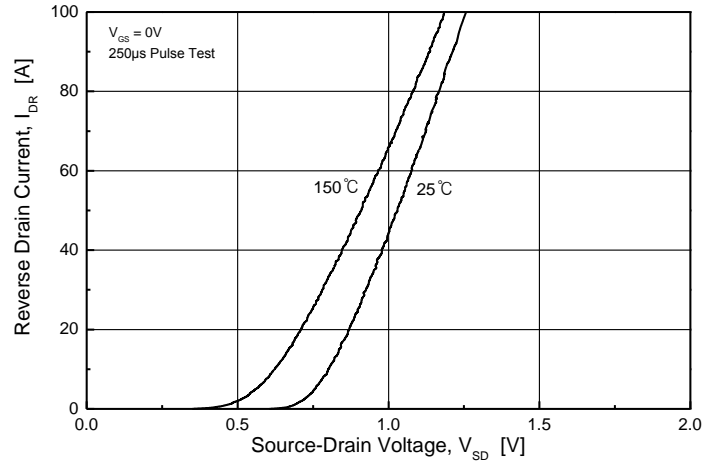
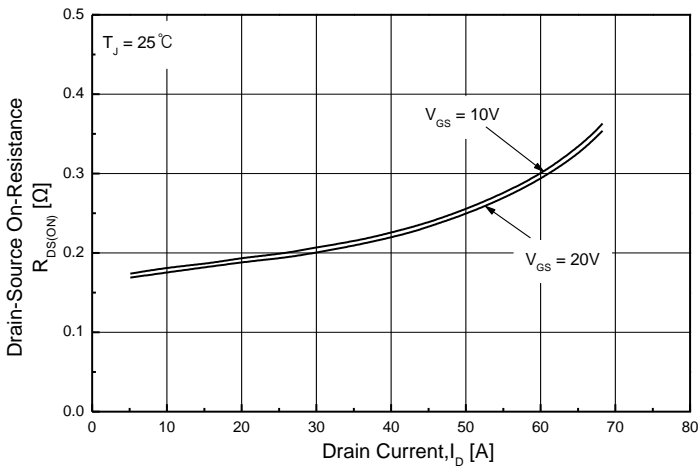
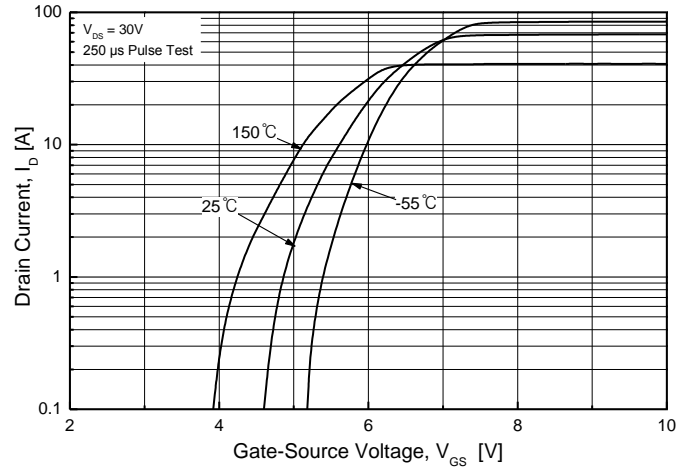
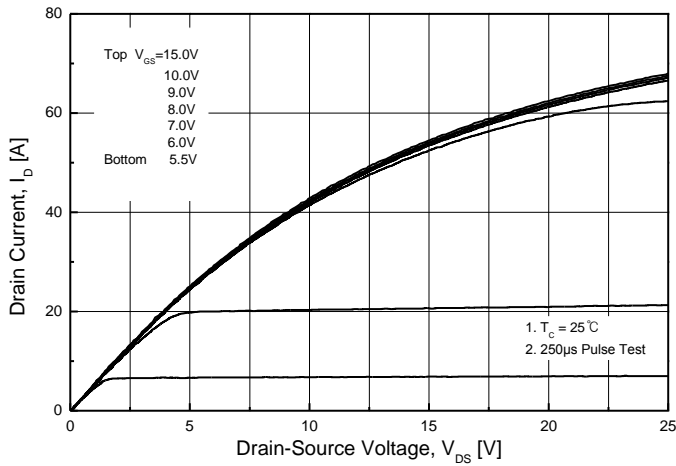

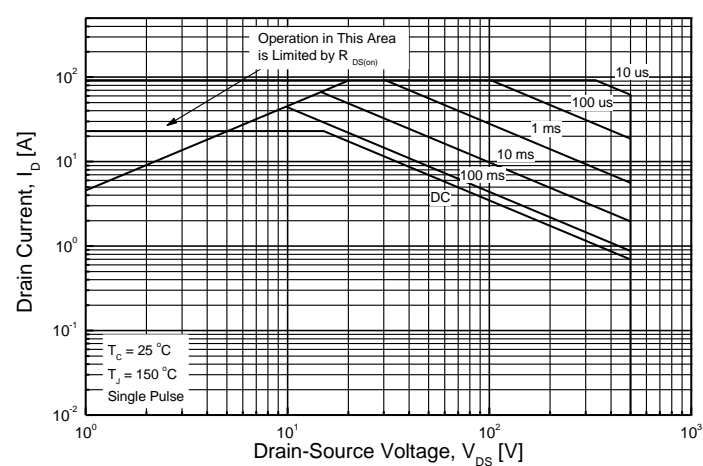
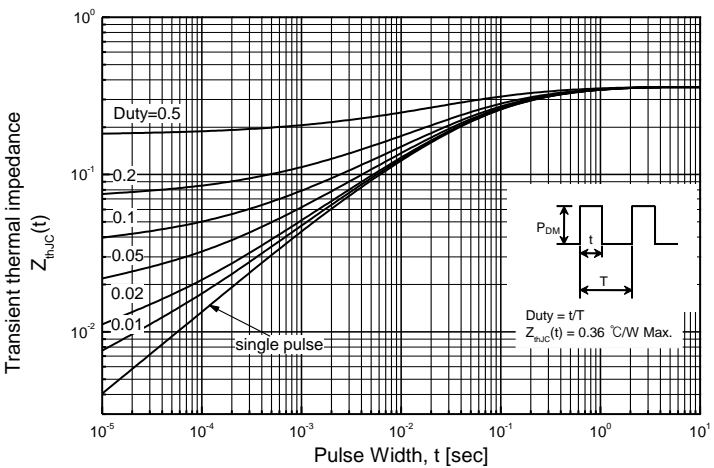
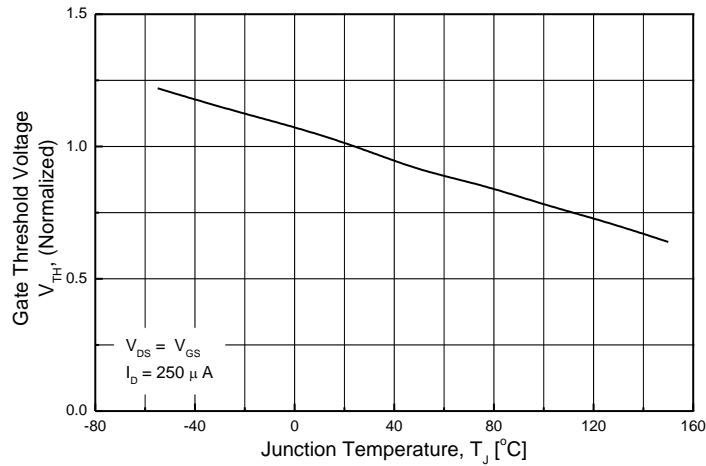
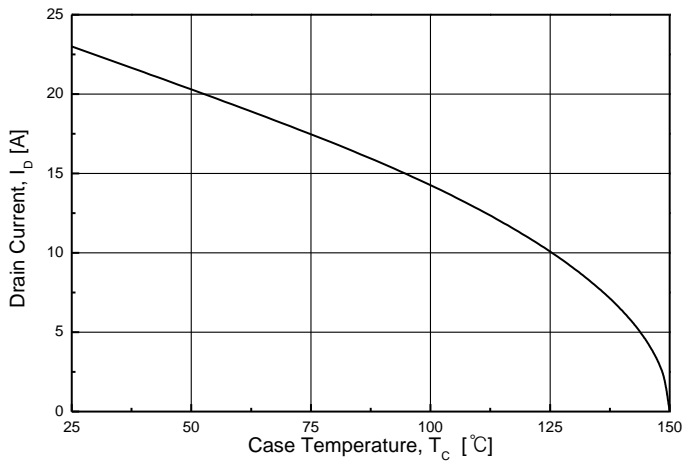
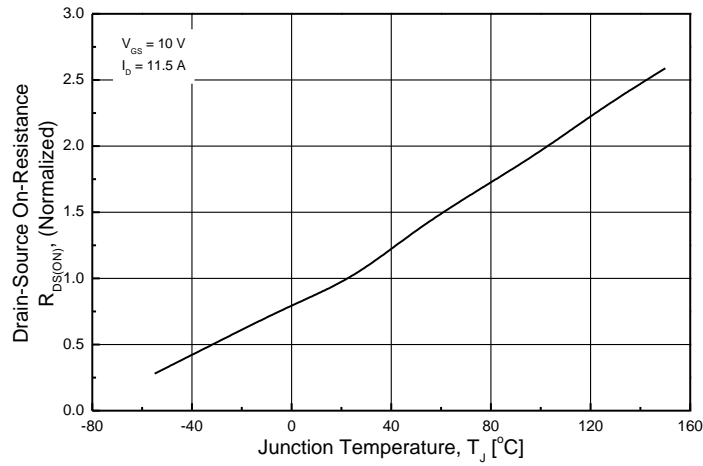
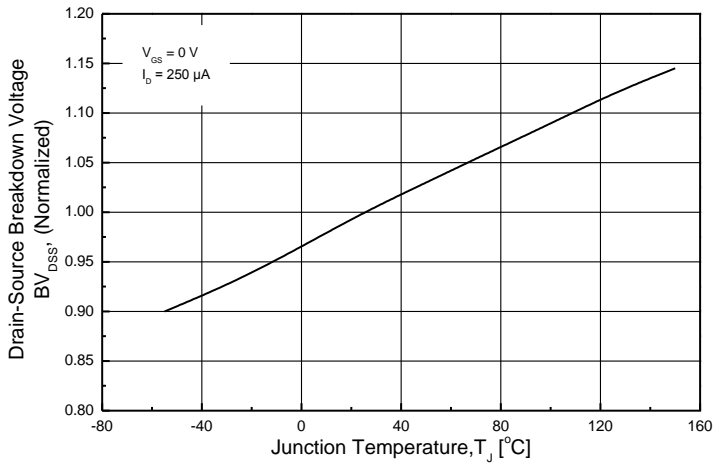

**TO-3PN MECHANICAL DATA**

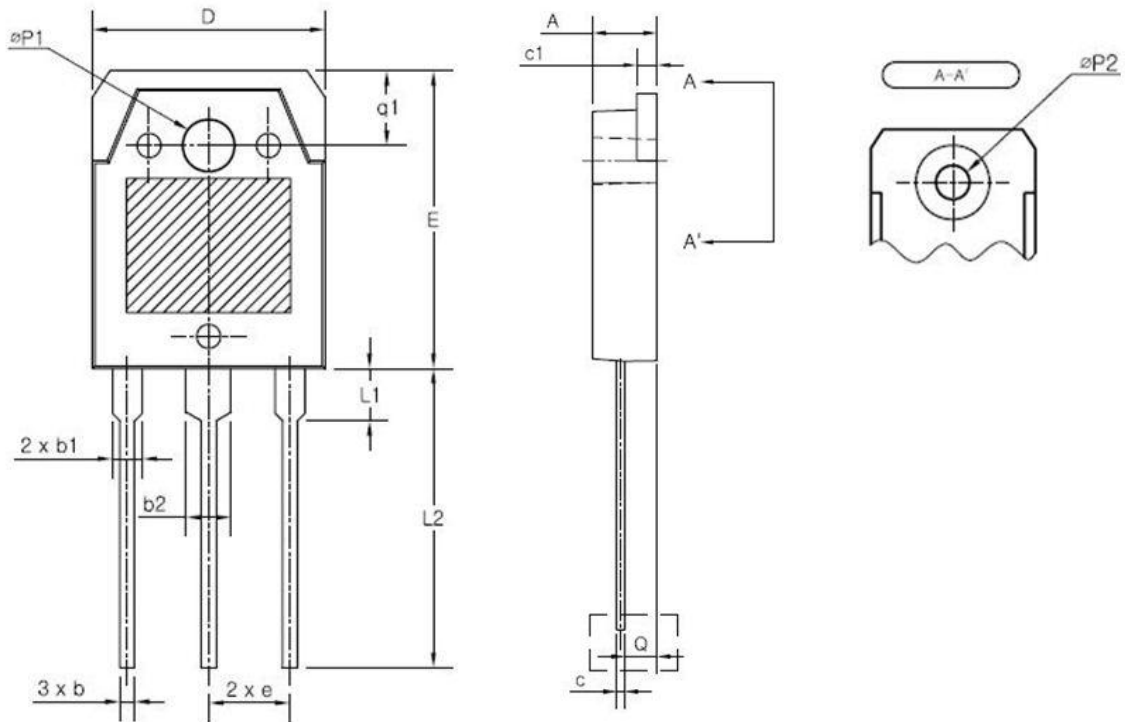

SYMBOL	MIN	NOM	MAX
A	4.60	4.80	5.00
b	0.80	1.00	1.20
b1	1.80	2.00	2.20
b2	2.80	3.00	3.20
c	0.55	0.60	0.75
c1	1.45	1.50	1.65
D	15.40	15.60	15.80
E	19.70	19.90	20.10
e	5.15	5.45	5.75
L1	3.30	3.50	3.70
L2	19.80	20.00	20.20
$\varnothing P1$	3.30	3.40	3.50
$\varnothing P2$	(3.20)		
Q	2.20	2.40	2.60
q1	4.80	5.00	5.20